

This document must not be copied without our written permission, and the contents thereof must not be imported to a third party nor be used for any unauthorized purpose. Contravention will be prosecuted. Purus AB

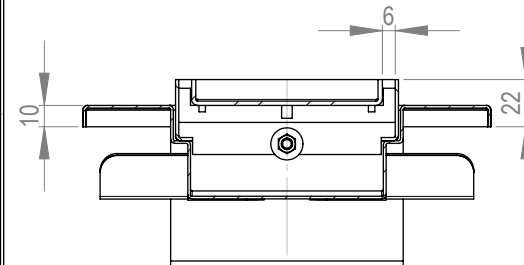

A-A

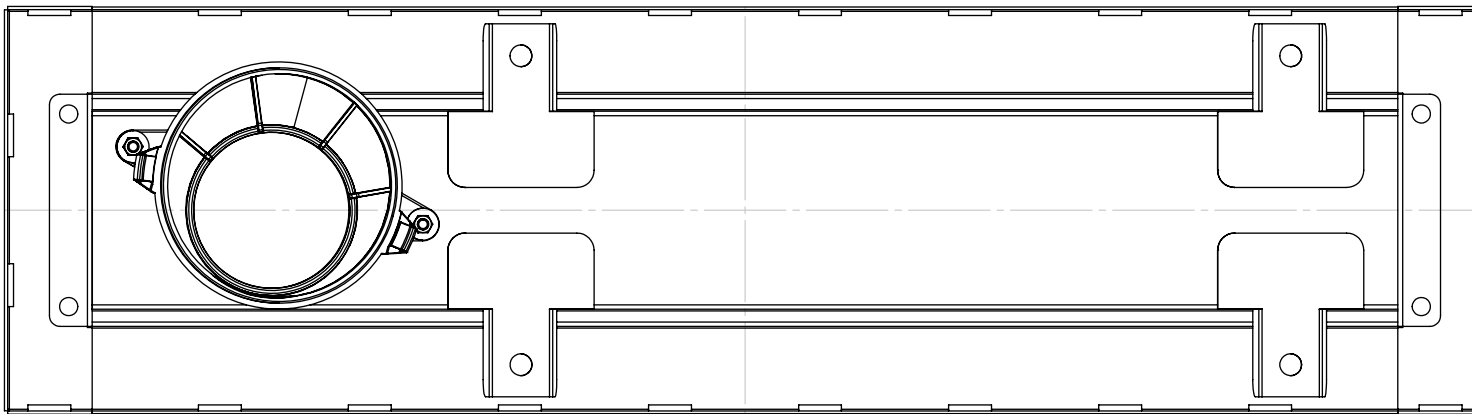
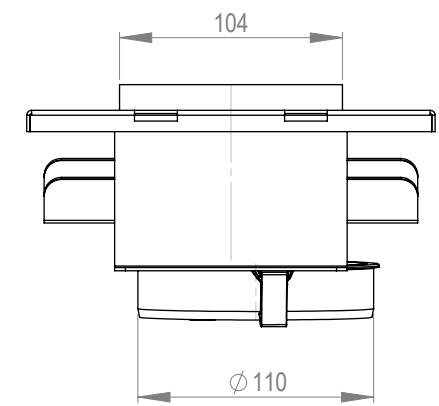
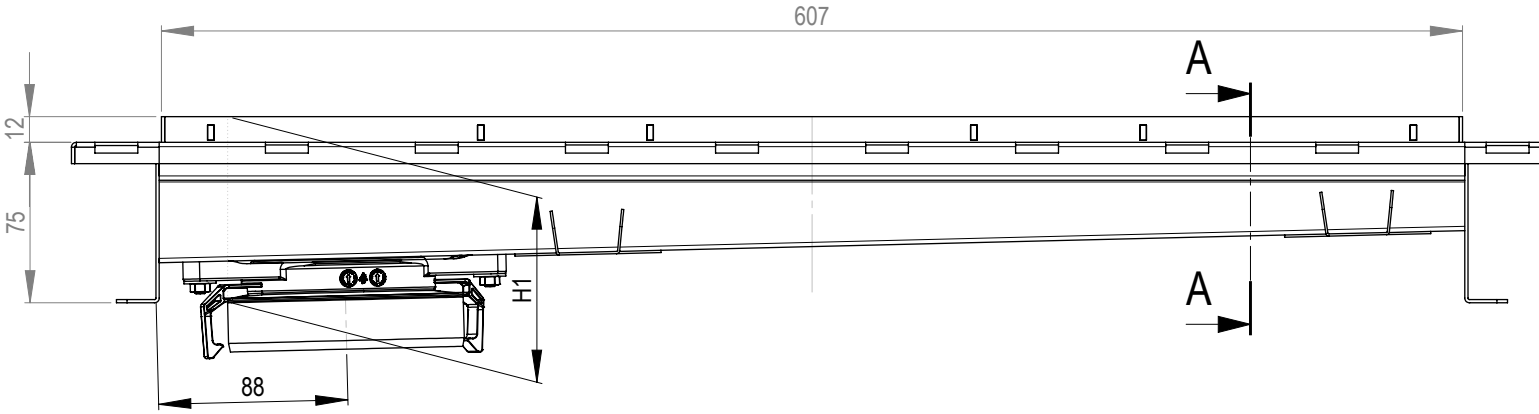

- Model 600 -- 1000: H1 = 87**
- Model 1100 -- 1500: H1 = 92**
- Model 2000 -- 2500: H1 = 97**

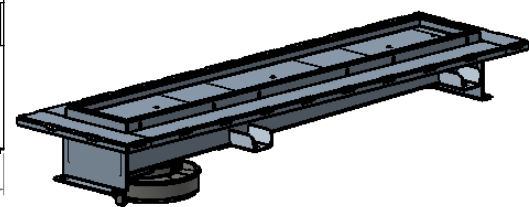
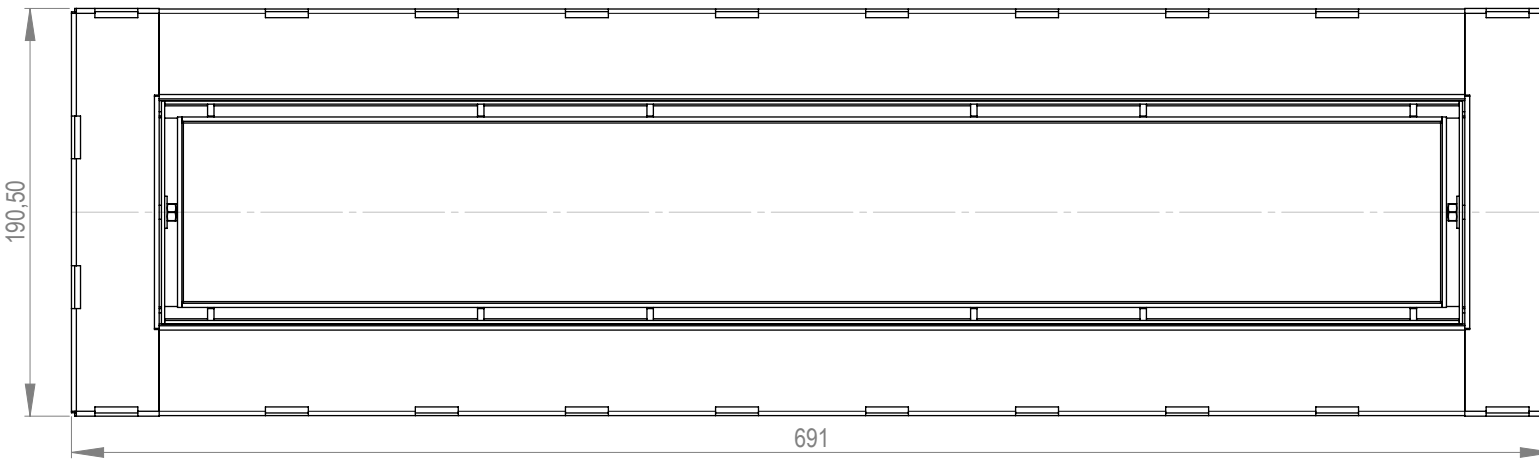

Den här handling får ej utan vårt medgivande kopieras. Den får ej heller delgivas annan eller ejlest oerhörigen användas. Överträdelse härav beivras med stöd av gällande lag. Purus AB

Annotation		A3		This drawing replace		Replaced by		Date	
				-		-		-	
 Purus AB Södra Dragongatan 15 SE-271 39 YSTAD, SWEDEN Ph. +46 104144900 Fax +46 104144996 www.purus.se		Scale	Page	General tolerance: ISO 2768-1	Weight (gram)	Volume (cm3)	Approved by	Date	
		1:2.5	1(1)		-	-	-	-	
Material		Surface treatment		Designer		Created date			
		-		SwS		2014-01-15			
Channel 100 for Tile Gluing Flange, End Outlet, Tile Insert, All Lengths									Edition
									1